

1. Foreword

This instruction manual contains standard, generic data and should be used with the seal family installation instructions. These instructions must be read and applied whenever work is done on the seal and must be kept available for future reference. These instructions are for the installation and operation of a seal as used in rotating machines and will help to avoid danger and increase reliability. Before use with other types of machines John Crane should be consulted. These instructions must be read in conjunction with the instruction manuals for both the machine and any ancillary equipment.

If the seal is to be used for an application other than that originally intended or outside its recommended performance limits, John Crane must be contacted before its installation and use. Any warranty may be affected by improper handling, installation, or use of this seal. Contact John Crane for information as to exclusive product warranty and limitations of liability.

If questions arise, contact your local John Crane Sales/Service Engineer or the original equipment manufacturer, as appropriate. John Crane mechanical seal are precision products and must be handled appropriately. Take particular care to avoid damage to lapped sealing faces.

2. Safety

The following symbols are used to highlight instructions of particular importance.

Note: Refers to special information on how to install or operate the seal most efficiently.

Attention: Special instructions or information to avoid damage to the seal or its surroundings.

 Danger Mandatory instructions designed to prevent personal injury or extensive damage.

 Environmental Note

- 1 Installation, removal and maintenance of the seal must only be carried out by qualified personnel who have read and understood these installation instructions.
- 2 The seal is designed exclusively for sealing rotating shafts. The manufacturer cannot be held liable for use of the seal for purposes other than this.
- 3 The seal must be used in technically perfect condition and must be operated within the recommended performance limits and in accordance with its designated use set out in this manual.
- 4 If the process fluid is hazardous or toxic, appropriate precautions must be taken to ensure that any seal emissions are adequately contained. Further information on sealing hazardous or toxic fluids should be obtained from John Crane prior to seal installation.
- 5 Fluorocarbon components should never be burned or incinerated, as the fumes and residues are highly toxic. If fluorocarbons are heated above 400°C/750°F they can decompose, therefore, personal protective equipment (PPE) should be worn as hydrofluoric acid may be present.
- 6 PTFE components should never be burned or incinerated as the fumes are highly toxic. It is dangerous to smoke while handling products made from PTFE. Follow the relevant local guidelines for the safe and proper environmental disposal of assembly lubricants, supplied fluids and scrapped components.

3. Hazardous Environments

 **Attention:** Every working practice which compromises safety must be avoided. In the event of an operating problem the machine must be switched off immediately and made safe! Problems must be solved promptly.

Minor emissions will occur during normal seal operation. Depending on the duty, this emission can appear as a gas, a liquid or a solid. For emissions that are hazardous or toxic and a safe collection system is required.

Hot surfaces have to be protected against accidental contact.

In order to avoid unforeseen hazards do not make unauthorised changes to the sealed fluid, the specific duty or the seal parts.

Some mechanical seals are used in conjunction with an ancillary support system; this is clarified either by the flush plan description on the seal arrangement drawing or by contacting John Crane (also see Section 11). It is important for the safe function of the seal that the support system is assembled and incorporated into the machine before operation. This manual should be read in conjunction with the appropriate documentation for auxiliary systems and rotating machinery.

 **Attention:** Alarm systems are often included in the ancillary support system and the operator must ensure appropriate action is taken promptly in the event of an alarm.

Maintenance with steel tools must be avoided in the presence of substances classed as explosive group IIC according to EN 60079-0:2012+A11:2013.

If the machine is being used in a EN 60079-0:2012+A11:2013 Zone 21 or 22, regular cleaning of dust from exterior surfaces is required.

4. Declaration of Incorporation (2006/42/EC)

For each standard product supplied into the EU a Technical File is required and a Technical Record Sheet, satisfying the needs of 2006/42/EC. When requested, a Declaration of Incorporation (for which a Technical File exists) will be raised and signed by a John Crane appointed representative.

5. Transportation and Storage

Transport and store the seal in its original packaging. To ensure seals remain in good condition they should be stored in the following environment:

- 1 Dry and dust-free
- 2 Ventilated at room temperature
- 3 Protected from direct effects of heat and ultraviolet light
- 4 All the elastomers used in the mechanical seal have a minimum shelf life of 5 years except for butyl rubber which has a minimum shelf life of 2 years. We recommend that the elastomers be replaced at these intervals. It is also recommended that the elastomer replacement be carried out by John Crane personnel.

 If used seal parts are to be shipped they must be cleaned and decontaminated before shipping. It is the responsibility of the machine user to ensure that any parts being shipped have appropriate safe-handling instructions externally attached to the package. Without this information there will be a refusal to handle the goods. If required a decontamination/transportation certificate is available from John Crane. Refer to document EDS1001.

For additional information on transportation and storage, contact your local John Crane facility and request a copy of document I-Storage.

If any machine with an installed component seal has been stored with preservatives, before putting it back into operation the seal must be removed, cleaned and dried. Particular attention must be applied to the cleanliness of the faces and condition of the elastomers. For an installed cartridge seal we recommend returning the complete cartridge to John Crane for cleaning.

Attention: Ensure preservatives and cleaning agents do not affect the elastomers

Attention: Once the seal is fitted on the machine and the position is set using setting devices do not re-engage them for transportation and storage.

6. Seal Installation

Refer to the appropriate seal family installation instructions.

Do not excessively compress the seal before or during installation.

7. Before Starting the Machine

- 1 Check the machine at the coupling for proper alignment of the driver.
- 2 Ensure that the gland plate nuts/bolts are securely tightened according to the machine manual instructions and that all screws are securely fastened.
- 3 Assemble the machine, ensure any setting spacers are removed from the seal and turn the shaft (by hand if possible) to ensure free rotation.
- 4 Consult all available machine instruction manuals to check for correctness of all piping and connections, particularly regarding seal recirculation, heating or cooling requirements and services external to the seal. See Section 11. Ensure all unused ports are correctly plugged.

Attention: Mechanical seals are normally designed to operate in a liquid so that the heat energy they create is adequately removed. Therefore, the following check should be carried out not only after seal installation but also after any period of machine inactivity.

- 5 Check that the seal chamber pipe work is open and free of any obstruction, and for liquid lubricated seals ensure that the seal chamber is properly vented and filled with liquid - refer to the machine instruction manual. See also Section 11.

Attention: Except for dry running or gas lubricated seals which are designed to operate without liquid, wet seals that are operated without adequate liquid lubrication will often give rise to a squealing noise from the seal area and result in overheating and scoring or other damage to the sealing surfaces, causing excessive emissions and a reduced seal life.

 Before start-up, ensure that all personnel and assembly equipment have been moved to a safe distance so there is no contact with rotating parts on the machine, seal, coupling or driver.

Attention: Seal installation should be handled only by qualified personnel. If questions arise, contact the local John Crane Sales/Service Engineer. Improper use and/or installation of this product could result in injury to the person and/or harmful emissions to the environment and may affect any warranty on the product. Please contact John Crane for information as to exclusive product warranty and limitations of liability.

8. Maintenance

During operation, periodic visual external inspection of the seal should be carried out. A measure of seal condition is the level of emission of the process or barrier fluid and as no maintenance is possible while installed, the seal should be replaced when emissions become unacceptable. It is recommended that a spare seal be held in inventory to allow immediate replacement of a removed seal.

Attention: Machine adjustments that involve axial movement of the shaft may cause damage to the seal while installed.

Before attempting impeller clearance adjustment with a cartridge seal, refit the spacers then loosen all the drive collar socket set screws. With the shaft in its new working position, tighten with new socket set screws and remove the spacers. Keep the spacers for future use.

For a component seal (non-cartridge), remove the seal, adjust the impeller clearance then re-fit the seal at its correct working length.

Decommissioning the Machine

1 Ensure that the machine is made safe to work on by using a secured isolation under the sole control of the person(s) working on the machine and which includes the following:

- the driver is fully isolated from the machine using an appropriate secured isolation method;
- any pressure is safely and fully released;
- any liquid is safely drained;
- any gas safely vented;
- any chemicals are safely and fully removed;
- any other energy storage is safely and fully released;
- the isolation is proved to be effective at the point of work before work is commenced.

⚠ If the machine has been used on toxic or hazardous fluids, ensure that the machine is correctly decontaminated and made safe prior to commencing work. Remember that fluid is often trapped during draining and may be present inside the seal chamber. The machine instruction manual should be consulted to check for any special precautions.

Removing the Seal

Note: Remove from the machine with care, the seal may be suitable for reconditioning after service, if otherwise undamaged.

1 Referring to the machine instruction manual, dismantle the machine sufficiently to expose the seal and the seal housing.

Attention: For a cartridge seal, the setting spacers must be refitted before starting the removal procedure.

2 Deburr, clean and lubricate the shaft over which the seal will pass and remove the seal unit in the reverse order to installation.

A mechanical seal must always be serviced after removal from the machine. In order to maximise reliability and minimise safety risks, it is strongly recommended that used seals are returned to John Crane for rebuilding to as-new specification (essential for non-contacting gas seals). Alternatively ask for John Crane service personnel to visit site. For seal dismantling and assembly instructions, refer to John Crane.

See "Transportation and Storage" section regarding shipping.

⚠ Note: It is recommended that a low pressure integrity test is carried out after repair and before installation on the machine.

Spare Parts

Only John Crane spare parts should be used to recondition seals.

It is advisable to stock on site sufficient spare seal cartridges or the replacement parts shown on the installation drawing or as advised by John Crane to allow immediate replacement of the seal in the machine. The order codes for spare parts can be found in the parts list on the installation drawing or from John Crane directly. In the case of non-contacting gas seals, only complete cartridges should be stored.

The following data is necessary for spare part orders:

Part number; Quantity

9. Environmental Aspects

Company Policy Extract

"It is the policy of John Crane to manage its business activities in an environmentally responsible manner, comply with all relevant laws and regulations,

prevent pollution, and continually improve its environmental performance, certification to the latest issue of ISO 14001 ensures compliance."

John Crane adopts the 'Design For the Environment' (DFE) principle in making this product. Using this product will benefit the environment directly by:

- **Preserving valuable material resources** through recycling of raw materials, the use of environmentally friendly packaging materials, the re-use of these high quality durable seals due to their ability to be refurbished and minimized transportation using world wide manufacturing and service centres .
- **Reducing waste** of precious resources through decreasing the risk of leakage
- **Reducing energy consumption** through seal selection using total life costs
- **Preventing pollution** through controlling harmful emissions to the atmosphere

Recycling Product Refurbishment

🔄 This product has been designed for potential reuse. Depending on its post operation condition the seal may be repaired or rebuilt for further use. The metal components can generally be reused. The primary & mating rings may be re-lapped and reused. Drive screws and springs are replaced. O-rings must be replaced. Please consult John Crane for assessment of seal condition and its potential reconditioning.

Disposal

When the product is considered to be beyond economical repair and potential reuse, it should be disposed of by environmentally beneficial means. The product can be disassembled with ease but appropriate personal protective equipment (PPE) should be worn to prevent contact with any harmful residue that may be inside the seal.

Scrapped components

These should be handled with extra care due to possible contamination. They should be recycled through approved local industrial recycling plants.

Special materials

Follow the local relevant guidelines for the environmentally friendly disposal of assembly lubricants, supplied fluids and scrapped components. Please refer to Section 2, Safety.

Packaging

All packaging materials used are made from recyclable, environmentally friendly materials. When in doubt or for further information and advice on this subject, please consult John Crane.

10. Quality Assurance

This seal has been assembled in accordance with John Crane Quality Assurance Standards and with proper machine maintenance and use will give safe and reliable operation to the maximum recommended performance as shown in any relevant approved John Crane publication.

11. Mechanical Seal Piping Plans

To create the optimum environment for the mechanical seal it is usually necessary to add piping and sometimes extra equipment.

For advice on a specific application please contact John Crane.

For liquid lubricated seals, venting of air trapped around the seal faces is essential for correct seal operation. For horizontal machines the best method of automatically achieving this is a piping connection at top dead centre (TDC). For vertical machines a piping connection above the seal faces is required.

12. Website

These instructions and other seal information can be found at www.johncrane.com

Fitting Lubricants

Elastomers & PTFE	Lubricant
General applications	Soft hand soap/water solution, glycerine (glycerol)
Food, pharmaceutical or similar	Consult machine manufacturer
NOTE: Always use a lubricant that is compatible with the machine and any ancillary machine and sealed product. Use lubricant sparingly.	

Introduction

This document covers fitting of the mechanical seal to rotating machinery and should be kept for future reference. It should be used with any instruction manuals supplied with the rotating machinery and any ancillary equipment.

The mechanical seal contains precision lapped components which have been designed to minimise process fluid emissions when selected, fitted and used correctly.

! If the process fluid is toxic or hazardous, appropriate precautions must be taken to contain any emissions.

! Never burn any of the rubber or plastic parts of the mechanical seal. Toxic fumes may be generated.

Attention: The machinery operating conditions must not exceed the published operating limits of the mechanical seal.

Attention: Take care when handling the mechanical seal as it contains precision lapped parts.

Note: Operating limits and all dimensions can be found at www.johncrane.com

The operating limits will depend on the materials used.

Table 1 Socket Set Screw Tightening Torque – All Except 5600 Series

Screw Size	Torque (Lubricated) Nm/lbf-ft	Screw Size	Torque (Lubricated) Nm/lbf-ft
M5	3/2.2	1/4-20 UNC	7.9/5.8
M6	4/3	5/16-18 UNC	14.7/10.8
M8	11/8.1	3/8-18 UNC	26/19.2

Table 2 Socket Set Screw Tightening Torque – 5600 Series Only

Seal Size Code	Screw Size	Torque Nm/lbf-ft	Screw Size	Torque Nm/lbf-ft
Up to 0480	M5	3.5/2.6	#10-24 UNC	3/2.2
0500 to 1206	M6	7/5.2	1/4-20 UNC	8/5.9
1250 & above	M8	15/11.1	5/16-18 UNC	15/11.1

Installation Instructions

Before installing the mechanical seal read the instructions carefully. Keep for future use. Seal installation must only be carried out by a suitably qualified person.

- 1 Check that the machine is clean and meets the fitting tolerances in Fig 2.
- 2 Unpack cartridge, inspect for damage, wipe clean.
- 3 Lubricate the machine shaft or sleeve with a recommended lubricant. See lubricant table.
- 4 Slide the cartridge on to the machine shaft or sleeve and rotate until the barrier inlet port ports are in a suitable position for flush piping.
- 5 Ensure that gland plate sealing ring is in position then slide the cartridge against the seal chamber.
- 6 Fit the gland plate fasteners and evenly tighten to the torque recommended by the machine manufacturer.
- 7 Ensure the machine shaft is locked axially in its final correct position and evenly tighten the cartridge drive collar socket set screws. See Table 1 or 2 depending on cartridge type for torque values.
- 8 Remove any setting clips or spacers and store for future use in cartridge removal.

Seal Dimensions

Fig 1

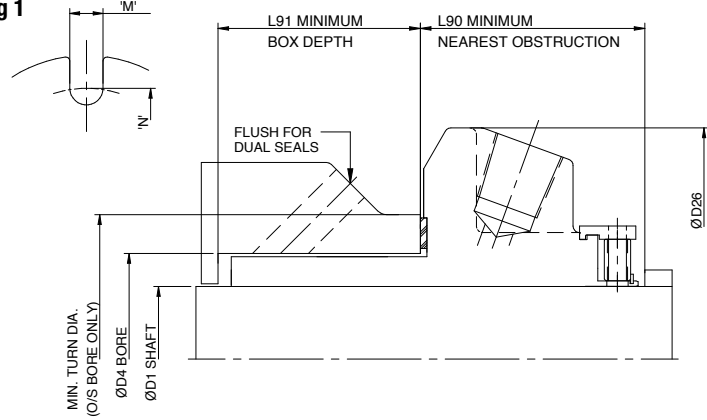

Checking The Machine

Fig 2

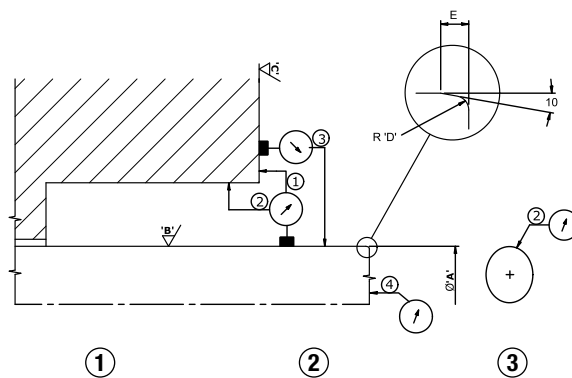

- A Seal Size
- B 0.2-0.5 µm Ra
8-20 pinch Ra
- C 1.6-3.2 µm Ra
Ra 63-125 pinch Ra
- D 1 mm/0.040 inch
- E 1.5 mm/0.060 inch

①	②	③	④
Squareness of shaft to seal chamber face	Concentricity seal chamber bore to shaft	Shaft runout	Shaft end play
0.001 mm/mm diameter 0.001 inch/inch diameter	<0.13 mm FIM <0.005 inch/FIM	<0.05 mm FM <0.002 inch/FIM	<0.13 mm FIM <0.005 inch/FIM

9. Turn the machine shaft by hand if possible to ensure free rotation with no shaft binding.
10. Complete the required piping to the seal. See Fig 3 and pages 4 and 5. Take care not to use excessive thread sealant when making circulation pipe work connections. Unused tapped connections must be safely plugged before seal operation.
11. Ensure machine seal chamber and seal are safely vented before starting the machine. This should be achieved through self-venting pipework. When manual vents are necessary they must be installed and used safely.
12. For liquid lubricated dual seals ensure that the seal lubrication system is correctly filled with suitable liquid. See Table 4 for guidance on liquid selection.
13. For a dual pressurised arrangement ensure that the seal is pressurised to a minimum of 1bar above the maximum machine seal chamber pressure before the machine is pressurised. The seal pressure must be within the seal and seal lubrication system operating pressure.

Once fitted, no adjustment is possible during the life of the mechanical seal.

When the mechanical seal requires replacement, John Crane can supply a new or reconditioned seal to the original specification.

Typical Flush Piping For Single Seals

Fig 3 Plan 11 –
commonly used with single seals on horizontal shafts

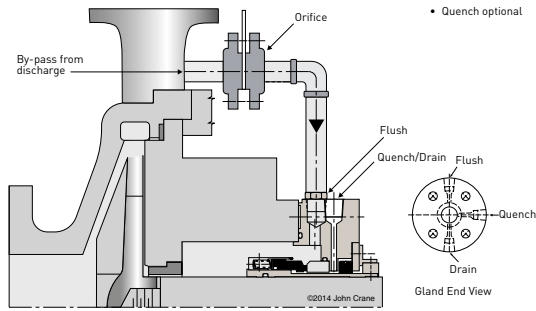

Plan 13 –
commonly used with single seals on vertical shafts

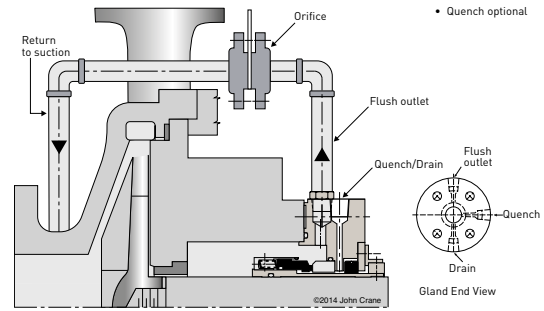

Plan 23 – commonly used with hot processes

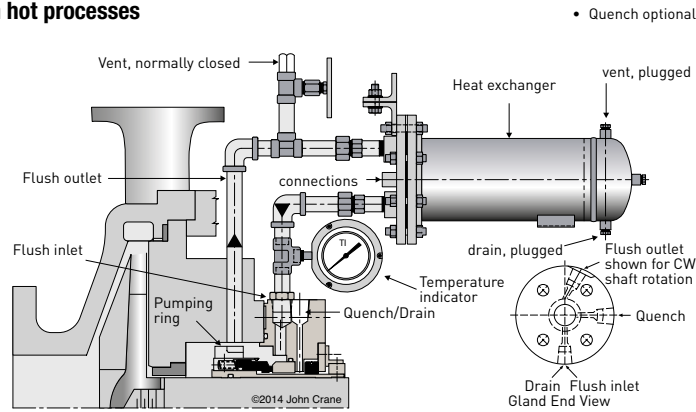

Typical Seal Cross Section

Type 5610

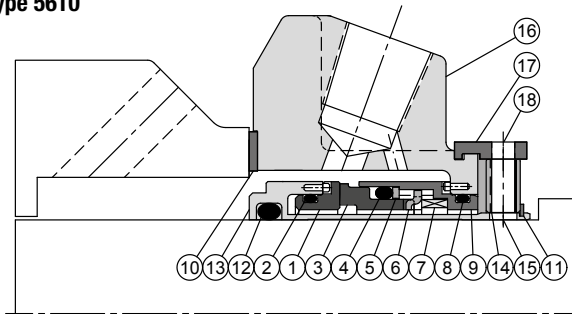

- | | |
|-----------------------|------------------------|
| 1 Mating Ring | 10 Gasket |
| 2 O-Ring | 11 Snap Ring |
| 3 Primary Ring | 12 O-Ring |
| 4 O-Ring | 13 Sleeve Ass'y |
| 5 Anti-Extrusion Ring | 14 Collar |
| 6 Drive Ring | 15 Set Screw |
| 7 Spring | 16 Gland Plate Ass'y |
| 8 O-Ring | 17 Spacer |
| 9 Retainer | 18 Socket Hd Cap Screw |

Type 5620

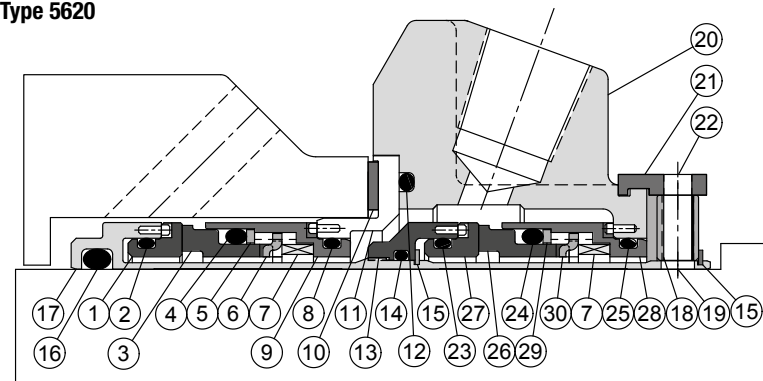

- | | |
|------------------------|------------------------|
| 1 Mating Ring | 16 O-Ring |
| 2 O-Ring | 17 Sleeve Ass'y |
| 3 Primary Ring | 18 Collar |
| 4 O-Ring | 19 Set Screw |
| 5 Anti-Extrusion Ring | 20 Gland Plate Ass'y |
| 6 Drive Ring | 21 Spacer |
| 7 Spring | 22 Socket Hd Cap Screw |
| 8 O-Ring | 23 O-Ring |
| 9 Retainer | 24 O-Ring |
| 10 Gasket | 25 O-Ring |
| 11 Gland Adapter Ass'y | 26 Primary Ring |
| 12 O-Ring | 27 Mating Ring |
| 13 Sleeve Adaptor | 28 Retainer |
| 14 O-Ring | 29 Anti-Extrusion Ring |
| 15 Snap Ring | 30 Drive Ring |

SERIES GLAND INSTALLATION GUIDE

Installation, Operation & Maintenance Instructions

Piping Connections

A cast gland plate is normally used up to shaft sizes 75 mm/3.000 inch. A letter identifying the function may be marked on the blank pads as follows:

- 'D' – Drain
- 'F' – Flush
- 'Q' – Quench
- 'I' – Buffer/Barrier Inlet
- 'O' – Buffer/Barrier Outlet
- 'V' – Vent

All standard pipework connections are tapped 3/8 inch NPT.

Special 5610 and 5615 seals may use a dual seal gland plate with a single seal, for conical seal chambers. All ports are plugged. Use no flush. A quench bush allows a quench by piping ports 1 and 3 as shown for "Single Seal with Quench".

Seal sizes above 75 mm/3.000 inch use a fully machined gland plate with radial drillings that allow bi-directional shaft rotation. Pipework connections are tapped 1/2 inch NPT.

Attention:

Some gland plates will have unused connections sealed with metal plugs.

As supplied, these gland plates have metal plugs fitted as follows:

Inch sizes – see relevant clockwise ANSI pump illustrations
mm sizes – see relevant clockwise DIN pump illustrations

Remaining connections are fitted with temporary plastic blanking plugs that cannot hold pressure. All plugs should be left in place until connection of the pipework. Plastic plugs must be replaced with metal plugs or appropriate fittings.

NOTE: Ensure the seal is correctly piped & plugged as shown in the relevant illustration for the particular application. Due to the wide variety of design of pumps & other machines the piping illustrations may not be valid in all cases. Consult John Crane if an alternative piping arrangement is required.

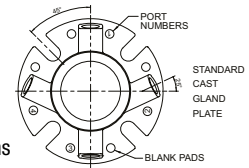

Sizes To 75 mm/3 inch DIN Pumps Clockwise Rotation

Single Seal with Flush

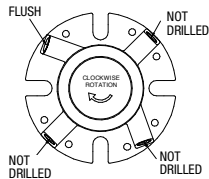

Single Seal with Quench

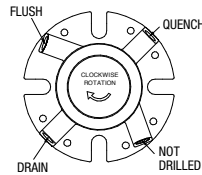

Dual Seal Preferred Arrangement

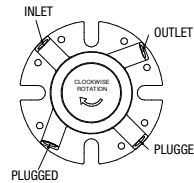

Dual Seal Optional Arrangement

NO OPTION AVAILABLE

Sizes To 75 mm/3 inch ANSI Pumps Clockwise Rotation

Single Seal with Flush

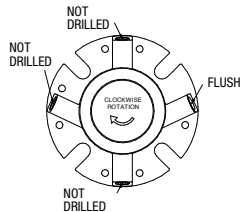

Single Seal with Quench

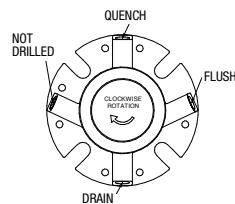

Dual Seal Preferred Arrangement

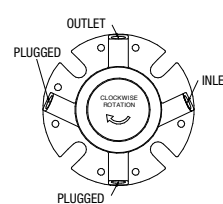

Dual Seal Optional Arrangement

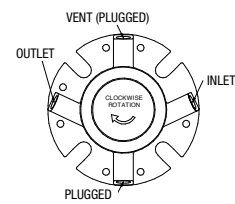

Sizes To 75 mm/3 inch DIN Pumps Counter Clockwise Rotation

Single Seal with Flush

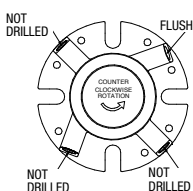

Single Seal with Quench

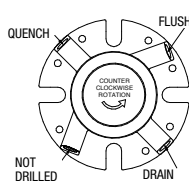

Dual Seal

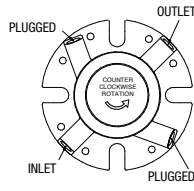

Sizes To 75 mm /3 inch ANSI Pumps Counter Clockwise Rotation

Single Seal with Flush

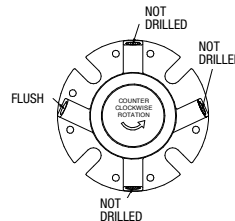

Single Seal with Quench

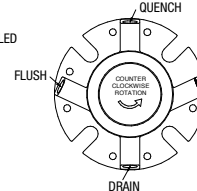

Dual Seal

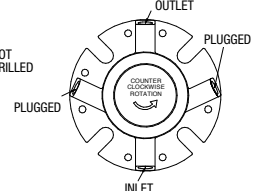

Sizes Over 75 mm/3 inch ANSI Pumps Bi-directional Rotation

Single Seals with Flush

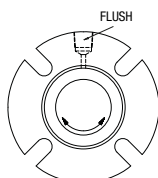

Single Seals with Quench

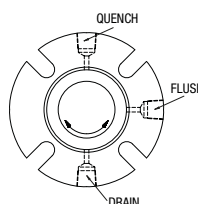

Dual Seals

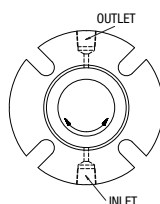

Notes

1. Direction of rotation is as viewed from the driver.
2. For single seal counter-clockwise applications a gland plate is required with port 4 drilled. If this port is not drilled contact your local John Crane Service Centre.
3. A plan 11/plan 13 flush for horizontal/vertical shafts is always recommended for single and dual seals.
4. Before starting the pump after seal fitting vent the seal chamber through the pump's lantern ring connection at TDC if safe to do so.
5. If manual venting of the seal is required, a safe method must be used. A self-venting installation is always the preferred option.
6. For seals over 75mm/3inch the connection positions may vary for other bolting arrangements.
7. For seals other than the 5600 series follow the installation guide on page 6.

Plan 52 - Dual unpressurized arrangement

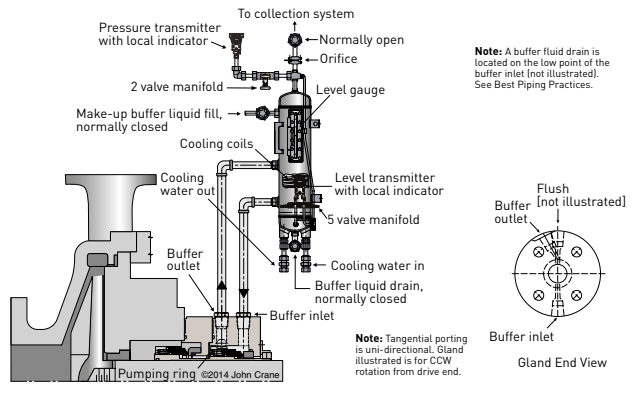

Recommendations For Gland Piping Seals Other Than The 5600 Series

NOTE: Thorough venting of the seal faces is essential for long seal life. Recommendations to achieve this are shown below.

1. For single seals on a horizontal shaft the flush should be at TDC to give a self-venting seal chamber. If this is not practical then either manually vent the seal chamber using the pump's lantern connection at TDC if it is safe to do so or drill a 5 mm / 3/16 inch hole in the pump throat bush at TDC.
2. For single seals on a vertical shaft the flush should be above the seal faces to ensure self-venting.
3. For dual seals on a horizontal shaft the barrier outlet should be at TDC to ensure self venting of the seal. If this is not practical then manually vent the seal if it is safe to do so. The seal chamber should be vented as described in paragraph 1.
4. For dual seals on a vertical shaft the barrier outlet should be above the upper seal faces to ensure self-venting. The flush connection should be above the level of the lower faces.
5. For a thermosiphon system follow the piping layout in Fig 5. A pumping ring is always recommended for use with a thermosiphon system.

Plan 53A - Dual pressurized arrangement

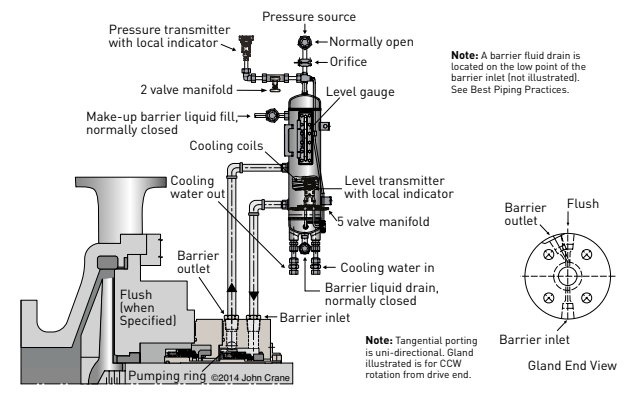

Plan 54- Piping layout

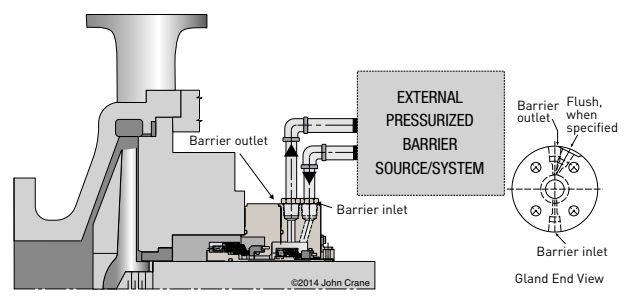

Plan 52/53A Piping layout

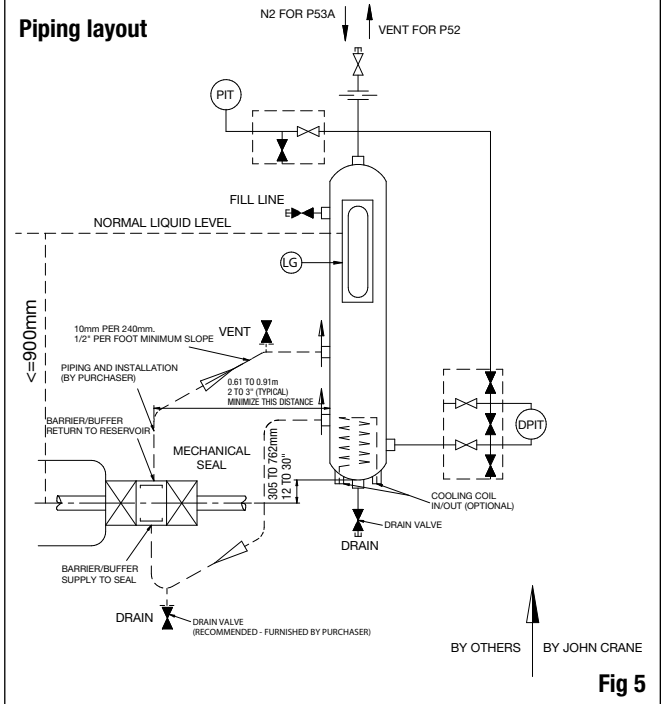

Fig 5

Notes

1. In a dual unpressurized arrangement the inboard seal is cooled and lubricated by the pumped liquid at seal chamber pressure. The outward seal is lubricated by the barrier liquid typically at atmospheric or flare pressure.
2. In a dual pressurized arrangement both seals are cooled and lubricated by the barrier liquid maintained at a pressure higher than the seal chamber pressure. This arrangement isolates the pumped liquid from the atmosphere.

Alternative Terms For Gland Plate Ports

Buffer/Barrier inlet – I, BI, LBI	Quench – Q
Buffer	Flush – F
Drain – D/Barrier outlet – O, BO, LBO	Heating – H (applies to jacket when fitted)
Vent – V	Cooling – C (applies to jacket when fitted)

Table 4 – Recommended Properties Of Barrier Liquids For Dual Seals:

- A good lubricant with good heat transfer properties
- Clean
- Compatible with the process fluid and seal materials of construction
- Stable over the seal's operating range
- Non-hazardous
- A viscosity < 15 cSt (80 SSU) @ 40°C (104°F) and ideally between 1 and 10 cSt (31 to 60 SSU) @ 65°C (150°F)
- A maximum viscosity of 150 cSt (680 SSU) at the minimum ambient temperature



TYPE 4610, 4620P, 5610, 5610Q, 5610P, 5610V, 5611, 5611Q, 5615, 5615Q, 5620, 5620P, 5620V, 5620VP, 5620VQ, 5625, 5625P, EZ-1, FFET, SB1, SB1A, SB2, SB2A, SBW

INSTALLATION INSTRUCTIONS FOR PUMP CARTRIDGE SEALS

Installation, Operation & Maintenance Instructions

Seal Type

Standard Bore Dimensional Data (Metric)

Size (mm)	SB1			SBW			SB2			FFET			EZ-1		
	D4 min	L90	N min	D4 min	L90	N min	D4 min	L90	N min	D4 min	L90	N min	D4 min	L90	N min
24	41.3	48	101.6	50.8	47.7	13.3	71.2	-	-	-	-	-	-	-	-
25	41.3	48	101.6	50.8	47.7	13.3	71.2	-	-	-	-	-	-	-	-
28	44.5	51.2	104.8	54	48.6	13.3	74.5	-	-	-	-	-	-	-	-
30	46.1	56.5	108	54	48.6	13.3	79.9	-	-	-	-	-	-	-	-
32	47.6	58.3	108	54	48.6	13.3	81.6	-	-	-	-	-	-	-	-
33	50.8	61.5	111.1	54	48.6	13.3	84.8	-	-	-	-	-	-	-	-
35	50.8	61.5	111.1	54.0	48.6	13.3	84.8	51	57	130	45.6	45.2	13	79	55
38	57.2	68.1	123.8	55.5	50.7	13.3	91.4	58	65	130	45.6	45.2	13	86	58
40	60.3	71.4	127.0	55.5	50.7	14.3	95.7	60	66	130	45.6	45.2	13.5	90	65
43	63	74.1	133.4	55.5	50.7	14.3	98.4	65	68	150	45.6	45.2	13.5	93	65
45	63	74.1	133.4	55.5	50.7	14.3	98.4	65	71	145	45.6	45.2	13	93	65
48	66.7	74.1	133.4	55.5	50.7	14.3	98.4	68	74	150	45.6	45.2	13	100	68
50	70	76.6	139.7	60.3	55.0	14.3	103.6	70	76	160	45.6	45.2	13	98	70
53	73	85.3	148.8	60.3	55.0	17.4	113.5	75	81	160	45.6	45.2	13	103	75
55	75	85.3	148.8	60.3	55.0	17.4	113.5	75	81	160	45.6	45.2	13	103	75
58	76.2	88.5	165.1	60.3	55.0	17.4	116.0	83	87	160	45.6	45.2	13	109	83
60	79.4	91.7	165.1	64.2	56.0	17.4	119.9	85	87	160	45.6	45.2	13	109	85
63	85.7	98.8	171.5	66.7	53.5	17.4	127.0	90	90	180	52.6	50.2	17	112	90
65	85.7	98.8	171.5	66.7	53.5	17.4	127.0	90	95	180	52.6	50.2	17	121	90
68	92.1	103.2	171.5	65.1	56.4	17.4	131.3	95	102	180	52.6	50.2	17	127	95
70	92.1	103.2	171.5	65.1	56.4	17.4	131.3	95	102	200	52.6	50.2	17	155	95
75	101.6	113.5	196.9	66.7	54.8	20.6	145.3	104	105	200	52.6	57.2	17	132	104
80	105.0	116.8	188.9	66.9	58.5	20.6	148.5	109	112	210	54.2	57.2	17	138	109
85	111.1	123.2	206.4	68.3	57.2	20.6	154.8	114	117	220	54.2	57.2	17	158	114
90	117.5	129.5	212.7	68.3	57.2	17.5	158.6	124	122	220	54.2	57.2	17	165	119
95	120.0	131.2	222.3	68.3	57.2	17.5	172	124	128	220	54.2	57.2	17	165	124
100	127.0	139.7	228.6	68.3	57.2	20.6	171.7	129	136	220	54.2	57.2	17	165	129
105	130.2	142.9	228.6	68.3	57.2	20.6	174.9	135	150	220	54.2	57.2	17	175	135
110	139.7	152.4	241.3	68.3	57.2	20.6	184.4	-	-	-	-	-	-	-	-
115	139.7	152.4	241.3	68.3	57.2	20.6	184.4	-	-	-	-	-	-	-	-
120	146.1	160.4	263.5	68.3	57.2	20.6	192.4	-	-	-	-	-	-	-	-
125	171.7	184.4	304.8	80.5	66.0	20.6	254.0	-	-	-	-	-	-	-	-
130	178.1	190.8	311.2	80.5	66.0	20.6	260.4	-	-	-	-	-	-	-	-
135	190.5	203.2	322.3	80.5	66.0	20.8	266.7	-	-	-	-	-	-	-	-
140	190.5	203.2	322.3	80.5	66.0	20.8	266.7	-	-	-	-	-	-	-	-
145	-	-	-	-	-	-	-	-	-	-	-	-	-	-	-
150	-	-	-	-	-	-	-	-	-	-	-	-	-	-	-

*Standard and large flange. **Seal plate dimensions to suit client.



TYPE

4610, 4620P, 5610, 5610Q, 5610P, 5610D, 5610V, 5610VQ, 5611, 5611Q, 5615, 5615Q, 5620, 5620P, 5620D, 5620VP, 5620V, 5625, 5625P, EZ-1, FFET, SB1, SB1A, SB2, SB2A, SBW

INSTALLATION INSTRUCTIONS FOR PUMP CARTRIDGE SEALS

Installation, Operation & Maintenance Instructions

D1 Shaft/ Seal Size (mm)	Seal Type												Large Bore Dimensional Data (Metric)												All dimensions in mm															
	5610, 5610D, 5610V, 5615				5610Q, 5610VQ, 5615Q				5611				5611Q				5620, 5620P, 5620VD, 5620VP, 5625, 5625P				5620, 5620P, 5620VD, 5620VP, 5625, 5625P				5620, 5620P, 5620VD, 5620VP, 5625, 5625P				5620, 5620P, 5620VD, 5620VP, 5625, 5625P											
	D4	D26	L90	L91	M	N	Min.	Turn Dia.	D4	D26	L90	L91	M	N	Min.	Turn Dia.	D4	D26	L90	L91	M	N	Min.	Turn Dia.	D4	D26	L90	L91	M	N	Min.	Turn Dia.	D4	D26	L90	L91	M	N	Min.	Turn Dia.
1.375	73.0	76.8	136.5	54.0	6.4	14.3	103.2	83.0	73.0	76.8	136.5	54.0	17.5	14.3	103.2	83.0	73.0	76.8	136.5	54.0	34.4	14.3	103.2	83.0	73.0	76.8	136.5	54.0	48.6	14.3	103.2	83.0	73.0	76.8	136.5	54.0	48.6	14.3	103.2	83.0
1.75	88.9	99.7	165.1	55.5	6.4	17.4	129.4	98.7	88.9	99.7	165.1	55.5	26.4	17.4	129.4	98.7	88.9	99.7	165.1	55.5	41.3	17.4	129.4	98.7	88.9	99.7	165.1	55.5	50.7	17.4	129.4	98.7	88.9	99.7	165.1	55.5	50.7	17.4	129.4	98.7
1.875	92.1	94.8	165.1	51.2	8.3	17.4	129.4	*	92.1	94.8	165.1	51.2	30.7	17.4	129.4	**	92.1	94.8	165.1	51.2	45.6	17.4	129.4	*	92.1	94.8	165.1	51.2	55.5	17.4	129.4	*	92.1	94.8	165.1	51.2	55.5	17.4	129.4	101.8
2.125	98.4	108.0	184.2	61.1	5.6	17.4	144.4	108.3	98.4	108.0	181.8	61.1	7.5	17.4	144.4	108.3	98.4	108.0	181.8	61.1	47.9	17.4	144.4	108.3	98.4	108.0	184.2	61.1	55.8	17.4	144.4	108.3	98.4	108.0	184.2	61.1	55.8	17.4	144.4	108.3
2.5	120.7	129.0	203.2	66.7	5.2	17.4	154.0	130.5	120.7	129.0	203.2	64.3	17.7	17.4	154.0	127.0	120.7	123.8	203.2	64.3	39.3	17.4	154.0	130.5	120.7	123.8	203.2	64.3	53.5	17.4	154.0	130.5	120.7	129.0	203.2	64.3	53.5	17.4	154.0	127.0
2.625	117.5	120.4	203.2	62.3	7.5	17.4	154.0	**	117.5	120.4	203.2	62.3	45.1	17.4	154.0	***	117.5	120.4	203.2	62.3	60.0	17.4	154.0	**	117.5	120.4	203.2	65.1	56.4	17.4	154.0	127.0	117.5	120.4	203.2	65.1	56.4	17.4	154.0	127.0
2.75	120.7	123.8	203.2	64.3	5.5	17.4	154.0	130.5	120.7	123.8	203.2	64.3	20.5	17.4	154.0	130.5	120.7	123.8	203.2	64.3	43.1	17.4	154.0	130.5	120.7	123.8	203.2	64.3	58.7	17.4	154.0	130.5	120.7	123.8	203.2	64.3	58.7	17.4	154.0	130.5

*Seal cartridge is OD registered on the Turn Dia. of 4.125.

**Seal cartridge is OD registered on the Turn Dia. of 5.125.

** Seal cartridge is OD registered on the Turn Dia. of 4.125.

*** Seal cartridge is OD registered on the Turn Dia. of 5.125.

* Seal cartridge is OD registered on the Turn Dia. of 4.125.

** Seal cartridge is OD registered on the Turn Dia. of 5.125.



TYPE 4610, 4620P, 5610, 5610Q, 5610P, 5610Q, 5611, 5611Q, 5615, 5615Q, 5620, 5620P, 5620Q, 5620V, 5620VP, 5620V, 5625, 5625P, EZ-1, FFET, SB1, SB1A, SB2, SB2A, SBW

INSTALLATION INSTRUCTIONS FOR PUMP CARTRIDGE SEALS

Installation, Operation & Maintenance Instructions

Seal Type

Large Bore Dimensional Data (Inches)

D1 Shaft/Seal Size (in)	5610, 5610D, 5610V, 5615										5611																						
	D4		D26		L90		L91		M		N		Min Turn Dia.		D4		D26		L90		L91		M		N		Min Turn Dia.						
	min	max	min	max	min	max	min	max	min	max	min	max	min	max	min	max	min	max	min	max	min	max	min	max	min	max	min	max					
1.375	2.875	3.023	5.375	2.125	2.250	0.250	0.562	4.062	3.268	2.875	3.023	5.375	2.125	0.791	0.562	4.062	3.268	2.875	3.023	5.375	2.125	0.688	0.562	4.062	3.268	2.875	3.023	5.375	2.125	0.688	0.562	4.062	3.268
1.750	3.500	3.925	6.500	2.187	0.250	0.687	3.885	5.093	3.885	3.500	3.925	6.500	2.187	0.744	0.687	5.093	3.885	3.500	3.925	6.500	2.187	1.038	0.687	5.093	3.885	3.500	3.925	6.500	2.187	1.038	0.687	5.093	3.885
1.875	3.625	3.734	6.500	2.017	0.327	0.687	5.093	*	4.264	3.625	3.734	6.500	2.017	0.915	0.687	5.093	*	3.625	3.734	6.500	2.017	1.209	0.687	5.093	**	3.625	3.734	6.500	2.017	1.209	0.687	5.093	**
2.125	3.875	4.250	7.250	2.407	0.219	0.687	5.687	6.062	4.264	3.875	4.250	7.156	2.407	0.806	0.687	5.687	4.264	3.875	4.250	7.156	2.407	0.297	0.687	5.687	4.264	3.875	4.250	7.156	2.407	0.297	0.687	5.687	4.264
2.500	4.750	5.078	8.000	2.625	0.204	0.687	6.062	5.139	5.139	4.750	5.078	8.000	2.532	0.698	0.687	6.062	5.000	4.750	4.875	8.000	2.532	1.547	0.687	6.062	5.139	4.750	4.875	8.000	2.532	1.547	0.687	6.062	5.139
2.625	4.625	4.740	8.000	2.454	0.296	0.687	6.062	**	4.625	4.625	4.740	8.000	2.454	0.884	0.687	6.062	**	4.625	4.740	8.000	2.454	1.774	0.687	6.062	***	4.625	4.740	8.000	2.454	1.774	0.687	6.062	***
2.750	4.750	4.875	8.000	2.532	0.218	0.687	6.062	5.139	5.139	4.750	4.875	8.000	2.532	0.806	0.687	6.062	5.139	4.750	4.875	8.000	2.532	1.696	0.687	6.062	5.139	4.750	4.875	8.000	2.532	1.696	0.687	6.062	5.139

*Seal cartridge is OD registered on the Turn Dia. of 4.125.

**Seal cartridge is OD registered on the Turn Dia. of 5.125.

** Seal cartridge is OD registered on the Turn Dia. of 4.125.

*** Seal cartridge is OD registered on the Turn Dia. of 5.125.

Seal Type

Large Bore Dimensional Data (Inches)

D1 Shaft/Seal Size (in)	5611Q										5620, 5620P, 5620VD, 5620V, 5625, 5625P																					
	D4		D26		L90		L91		M		N		Min Turn Dia.		D4		D26		L90		L91		M		N		Min Turn Dia.					
	min	max	min	max	min	max	min	max	min	max	min	max	min	max	min	max	min	max	min	max	min	max	min	max	min	max	min	max				
1.375	2.875	3.023	5.375	2.125	1.353	0.562	4.062	3.268	2.875	3.023	5.375	2.125	1.914	0.562	4.062	3.268	2.875	3.023	5.375	2.125	1.914	0.562	4.062	3.268	2.875	3.023	5.375	2.125	1.914	0.562	4.062	3.268
1.750	3.500	3.925	6.500	2.187	1.626	0.687	5.093	3.885	3.500	3.925	6.500	2.187	1.995	0.687	5.093	3.885	3.500	3.925	6.500	2.187	1.995	0.687	5.093	3.885	3.500	3.925	6.500	2.187	1.995	0.687	5.093	3.885
1.875	3.625	3.734	6.500	2.017	1.797	0.687	5.093	*	3.625	3.734	6.500	2.187	1.995	0.687	5.093	4.006	3.625	3.734	6.500	2.187	1.995	0.687	5.093	4.006	3.625	3.734	6.500	2.187	1.995	0.687	5.093	4.006
2.125	3.875	4.250	7.156	2.407	1.885	0.687	5.687	4.264	3.875	4.250	7.250	2.407	2.198	0.687	5.687	4.264	3.875	4.250	7.250	2.407	2.198	0.687	5.687	4.264	3.875	4.250	7.156	2.407	0.297	0.687	5.687	4.264
2.500	4.750	4.875	8.000	2.532	2.043	0.687	6.062	5.139	4.750	5.078	8.000	2.532	2.107	0.687	6.062	5.000	4.750	5.078	8.000	2.532	2.107	0.687	6.062	5.000	4.750	4.875	8.000	2.532	2.107	0.687	6.062	5.000
2.625	4.625	4.740	8.000	2.454	2.362	0.687	6.062	**	4.625	4.740	8.000	2.562	2.219	0.687	6.062	5.000	4.625	4.740	8.000	2.562	2.219	0.687	6.062	5.000	4.625	4.740	8.000	2.562	2.219	0.687	6.062	5.000
2.750	4.750	4.875	8.000	2.532	2.284	0.687	6.062	5.139	4.750	4.875	8.000	2.532	2.312	0.687	6.062	5.139	4.750	4.875	8.000	2.532	2.312	0.687	6.062	5.139	4.750	4.875	8.000	2.532	2.312	0.687	6.062	5.139

* Seal cartridge is OD registered on the Turn Dia. of 4.125.

** Seal cartridge is OD registered on the Turn Dia. of 5.125.



For your nearest John Crane facility, please contact one of the locations below.

- North America: North America, Houston, TX, Tel: +1-847-967-2400, Fax: +1-847-967-3915
- Europe: Slough, UK, Tel: +44-1753-224000, Fax: +44-1753-224224
- Latin America: Sao Paulo, Brazil, Tel: +55-11-3371-2500, Fax: +55-11-3371-2599
- Middle East & Africa: Dubai, United Arab Emirates, Tel: +971-481-27800, Fax: +971-488-62830
- Asia Pacific: Singapore, Tel: +65-6518-1800, Fax: +65-6518-1803

smiths
bringing technology to life

©2016 John Crane Revised 08/16 www.johncrane.com

If the products featured will be used in a potentially dangerous and/or hazardous process, your John Crane representative should be consulted prior to their selection and use. In the interest of continuous development, John Crane Companies reserve the right to alter designs and specifications without notice. All dimensions are in inches unless otherwise specified. PTFE, Old and new PTFE products must not be incinerated.

I-10MPCA/Eng